

Series	HG Series
Block Type	Flange Type
Model Size	65
Load Type	Super heavy Load
Block Mounting	Top or Bottom
Block	Standard Block
Preload Class	Medium Preload (0.05 ~ 0.07C)
Precision Code	C
Dust Protection	Standard protection (End seal and bottom seal)

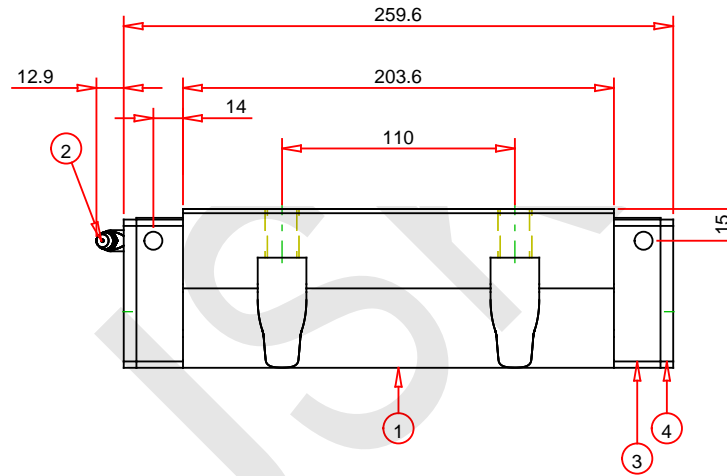
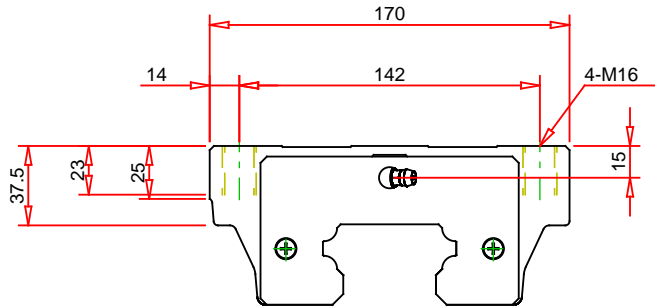

4	End Seal	2
3	End Cap	2
2	Grease Nipple	1
1	Block	1
No.	Part Name	Qty

Notes : - Drawing not to scale
- Dimensions subject to change without notice

Part No. :

HGW65HCZAC

Description :

HG Series - Interchangeable Type - Block

HIWIN
Motion Control and System Technology

Hiwin Technologies Corp.

Address : No. 7, Jingke Road
Taichung Precision Machinery Park
Taichung 40852, Taiwan
Tel. : +86 25 68021803
Email : sales@njskt.com
Web : www.njskt.com